

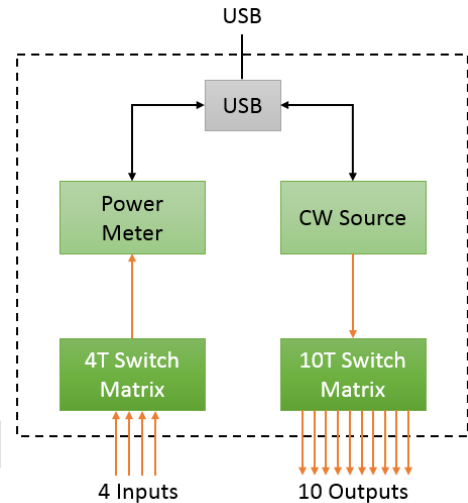

Product Features

- 0.1 ~ 8.0 GHz Wide Frequency Range
- Integrated CW Source
 - Very Low Spur
 - Low Phase Noise
 - Low Harmonics
- 10 Output Ports
- Integrated Power Meter and Sensor
 - RMS
- 4 Input Ports



WavesLine UMG802A is a broadband (0.1 ~ 8.0GHz), high performance, low cost multi-function RF test group box. The UMG802A integrates a USB interface, a CW signal generator with 10 output channels and a CW power meter with 4 input channels. This configuration significantly simplifies multi-port DUT test setup as well as control methods.

UMG802A functions with a single USB connection to host computer, and easily controlled by various Virtual Instrument software and coding languages. GUI software can track and control multi-connected UMG devices, and simplify multiple-signal test setups.

Typical Applications

- ATE & Lab Testing
- Semiconductor & RF System/Component
- Automotive & IoT
- Consumer Electronics
- High Education & Research



Absolute Maximum Ratings

Parameter	Ratings
Operation Temperature	0 °C ~ 50 °C
Storage Temperature	-30 °C ~ 85 °C
DC Power In	15V
RF Power Input Port	+27dBm CW

RF Specifications

Parameter	Specification				Condition
	Min	Typ.	Max	Unit	
RF Input Section					
RF Channel		4			
CW Frequency Range	0.1		8.0	GHz	
Max. RF Input Power			+20	dBm	
Noise Floor		-50		dB	@ 2.4GHz
		-40			@ 5.8GHz
Measurement Accuracy		0.2		dB	@Room Temperature
Power Resolution		0.01		dB	
Return Loss		-15		dB	
Detector Mode		RMS			



UMG802A USB MULTI-FUNCTION GROUPBOX

Parameter	Specification				Condition
	Min	Typ.	Max	Unit	
RF Output Section					
RF Channel		10			
CW Frequency Range	0.1		8.0	GHz	
Frequency Resolution		1		Hz	
Max. Output Power [Channel 5]		>15		dBm	< 7000MHz
		>-5		dBm	< 8000MHz
Min. Output Power [Channel 5]		<-60		dBm	< 7000MHz
		<-70		dBm	< 8000MHz
Output Power Step	0.05	0.1		dB	
Power Accuracy		±1.5		dB	
Phase Noise		-98		dBc/Hz	1k offset @ 4000M
		-102		dBc/Hz	10k offset @ 4000M
		-106		dBc/Hz	100k offset @ 4000M
		-135		dBc/Hz	1M offset @ 4000M
		-148		dBc/Hz	10M offset @ 4000M
Phase Noise		-93		dBc/Hz	1k offset @ 7000M
		-98		dBc/Hz	10k offset @ 7000M
		-102		dBc/Hz	100k offset @ 7000M
		-130		dBc/Hz	1M offset @ 7000M
		-148		dBc/Hz	10M offset @ 7000M
Harmonics		-59		dBc	0dBm @ 1000M
		-46		dBc	0dBm @ 2500M
Fractional Spur		<-80		dBc	



UMG802A USB MULTI-FUNCTION GROUPBOX

General Specification

Coaxial RF Connector	SMA Female
Dimension	270mm (L)
	207mm (W)
	61mm (H)
Device Driver	Windows Based Device Driver (not required for windows10 or higher)
API	Windows Based dll
Control Software	EXE, Windows OS, .Net Framework 4.7.2
USB Interface	USB2.0 Type B
USB Interface Standard	USB 2.0 Full Speed
Power Supply Voltage	+12VDC
Power Supply Current	1.0A

Front/Rear Panel

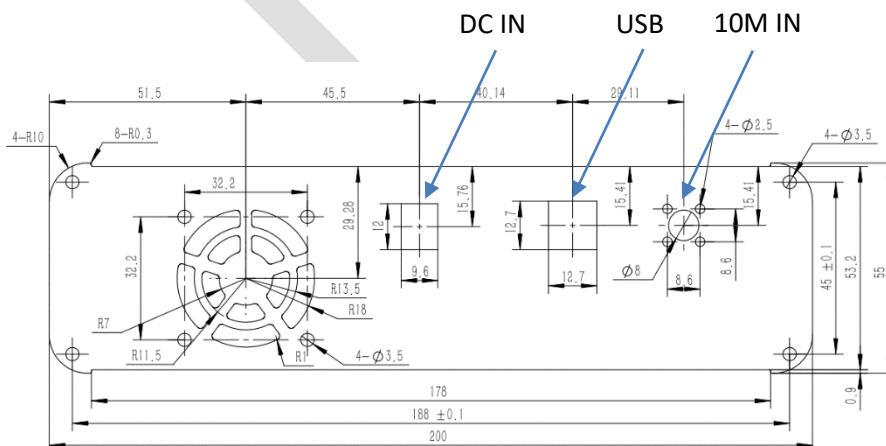
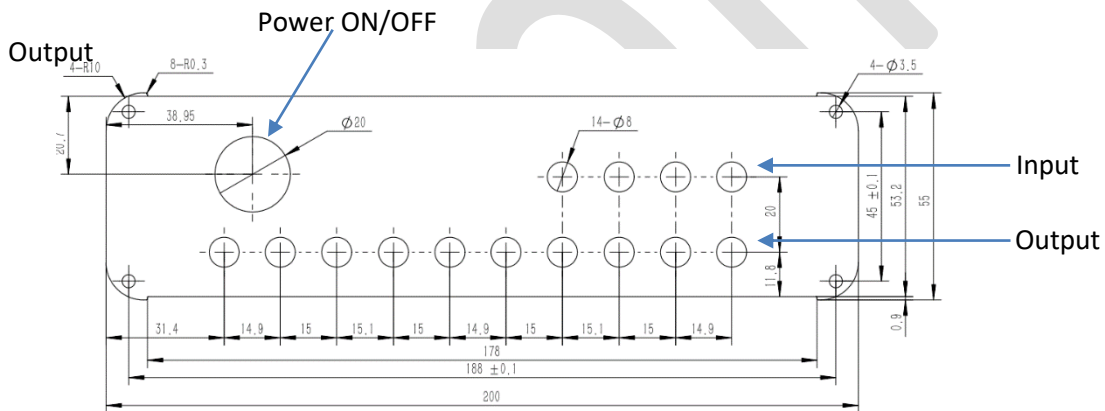



Typical Phase Noise

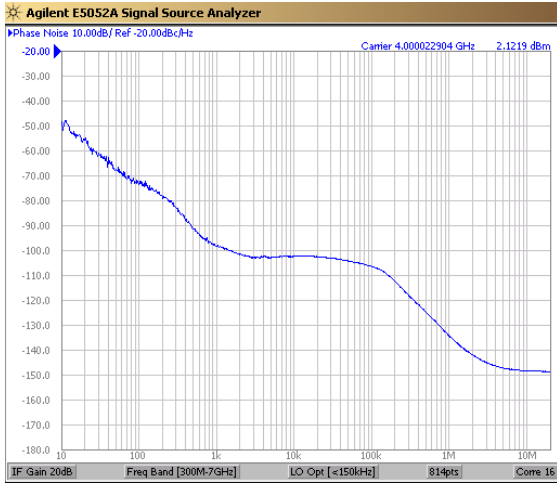

Phase Noise @ 4000M

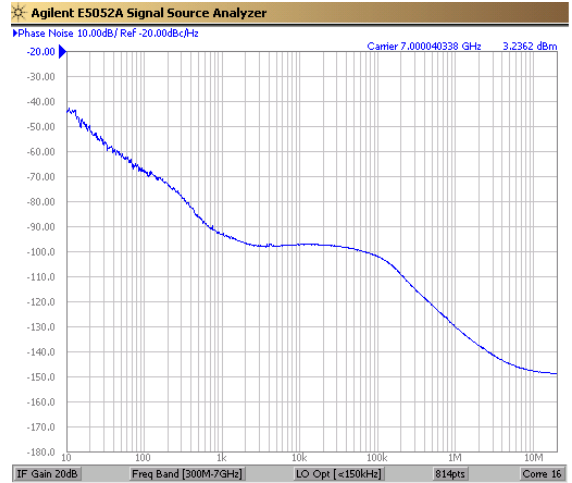

Phase Noise @ 7000M

Typical Spectrum and Spur

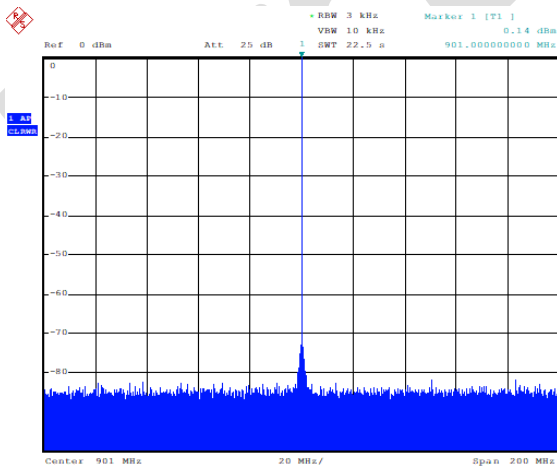

Spectrum @ 901M

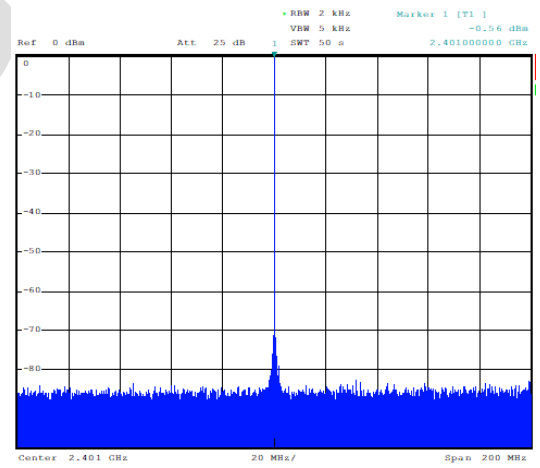

Spectrum @ 2401M



UMG802A USB MULTI-FUNCTION GROUPBOX

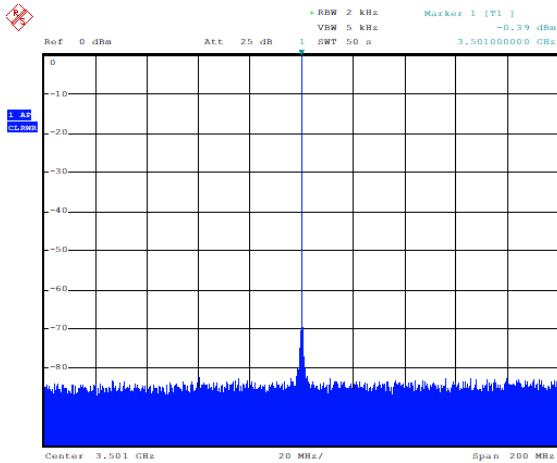

Spectrum @ 3501M

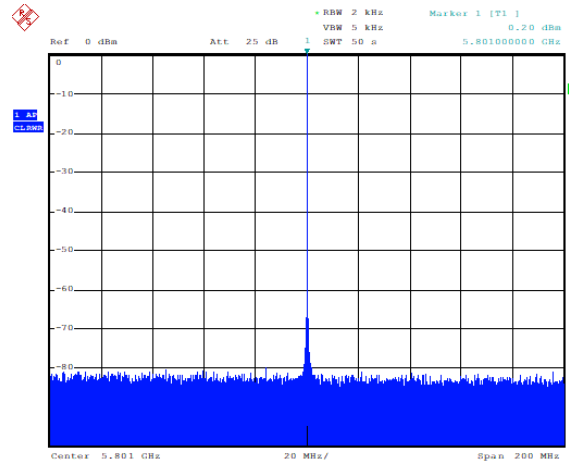

Spectrum @ 5801M

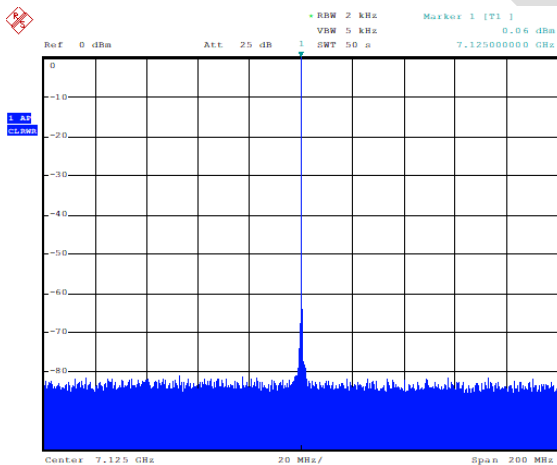

Spectrum @ 7125M

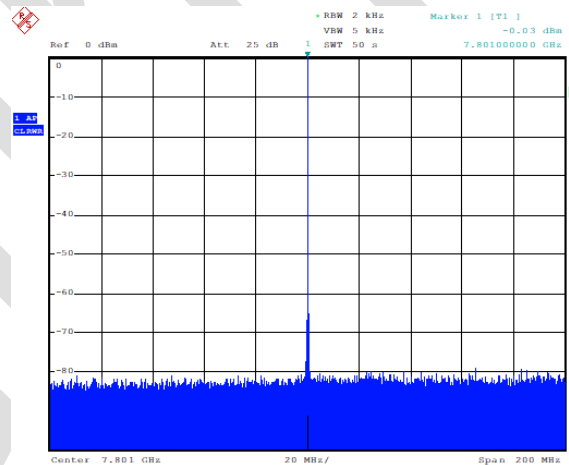

Spectrum @ 7800M

Typical Harmonics

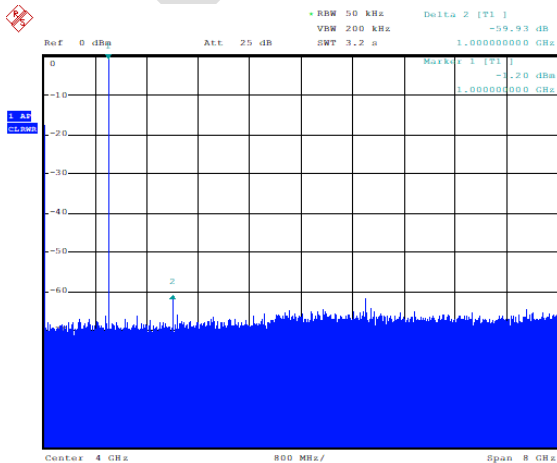

Harmonics @ 1GHz

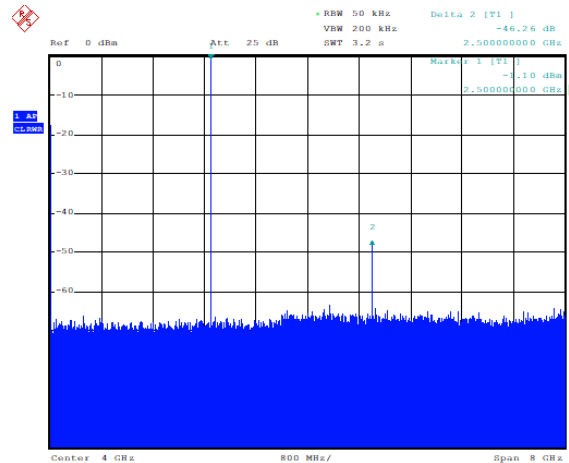

Harmonics @ 2.5GHz



Controlling the Signal Generator

The USB driver for Microsoft Windows 7, 8 System must be installed when attach the device to host computer. This driver only needs to been installed at the first time. The driver is developed over USB CDC protocol, which treats the USB device as a virtual serial port (COM) that can be easily controlled. Windows 10 is able to recognize UMG device and no drivers are required.

Waves-Line Control Software is an easy-to-use application software to control the device from host computer.

In an attempt to minimize customers' efforts in controlling the device via USB, Waves-Line offers easy-to-use dynamic link library (dll), which wraps a variety of functions such as, checking active ports that device is attached to, opening/closing connections to device, writing command to device, reading response from device and etc. The dll is wrapped to work over Microsoft .Net Framework 4.5.

Control Software

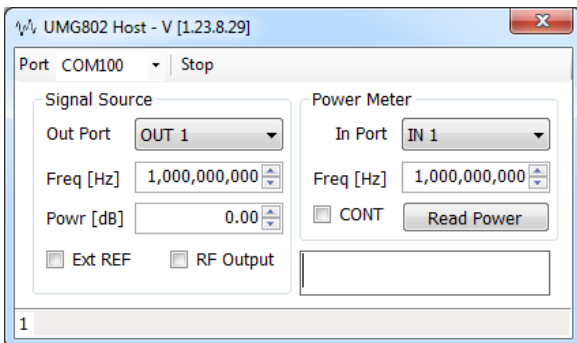



Command Format

Commands written to device must be in string formats, and all return values are in string format as well. The device control commands are listed below.

Note: A <CR> (“\n”, char 10 or 0x0A) need to be applied to the tail of all the commands.

***IDN?**

Query device information, it returns device information in string format.

***RST**

Soft Re-Start Device.

SN?

Query device Serial Number, it returns device SN information in string format.

FREQ[space]value

Set **Output** Frequency value[Hz], it returns the value when settings are done.

return: Value in unit of Hz;

POWR[space]value

Set device **Output** Power in Units of dB, it returns the value when settings are done.

return: Value in unit of dB;

OUTP[space]1/0

RF **Output** Power On/Off 1: RF ON 0: RF Off

return: 1 or 0

OPORT[space]value

Set **Output** Port, it returns the value when settings are done.

return: port number;

PMFREQ[space]value

Set **Input** Frequency value[Hz], it returns the value when settings are done.

return: Value in unit of Hz;

PM? Query **Input** Power

return: power value in unit of dB

IPOINT[space]value

Set **Input** Port, it returns the value when settings are done.

return: port number;



Recommended Procedure for Customer Program

<Read Input Power>

- 1, Set Input Port.
- 2, Set Frequency. This is important, Readings may not correct when frequency setting is incorrect.
- 3, Query Power Readings.

<Set Output>

- 1, Set Output Port.
- 2, Set Frequency.
- 3, Set Power Level.
- 4, Turn On RF Output.
- 5, Switch RF Frequency.
- 6, Switch RF Power.
- 7, Turn Off Output.